

## Frese PV Compact - adjustable differential pressure control valve

### Application

Frese PV Compact can be installed in domestic and commercial heating and cooling systems.

The valve is a dynamic, adjustable differential pressure control valve (DPCV) that ensures the differential pressure across the load or circuit is constant.

The valve ensures good modulating control and reduces the risk of noise from thermostatic radiator valves and 2-port control valves.

### Benefits

- High Kv value that achieves a low pressure loss and increased energy efficiency
- The valve offers adjustable differential pressure control
- Frese PV Compact eliminates noise problems caused by high differential pressure
- Differential pressure can be set and adjusted on site
- Tamper-proof presetting device on top of the valve, meaning there is no need for the valve sealing after presetting
- Presetting is simple using the graphs shown on pages 7-11



### Features

- Maximum differential pressure: 450 kPa
- Very compact size for easy installation
- Size DN15-DN50
- Maximum flow up to 11.500 l/h
- Connections ISO 228

# Frese PV Compact - adjustable differential pressure control valve

## Setting the valve

The valve is easily set by means of a 4mm hexagonal key. The flow rate of the valve can be determined from the flow rate graphs.

To set the valve to the desired downstream differential pressure, the valve should be set at the minimum position and then adjusted in accordance with the presetting graphs.

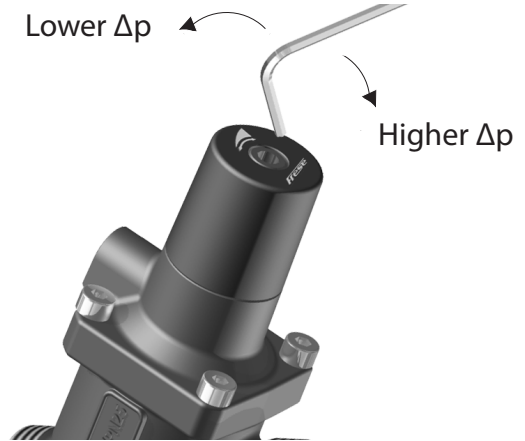

## Design

Frese PV Compact consists of a differential pressure regulation unit, an adjustable presetting and a capillary tube for connecting to the inlet pipe line.

Frese PV Compact must be installed in the return line with the capillary tube connected to the inlet line.

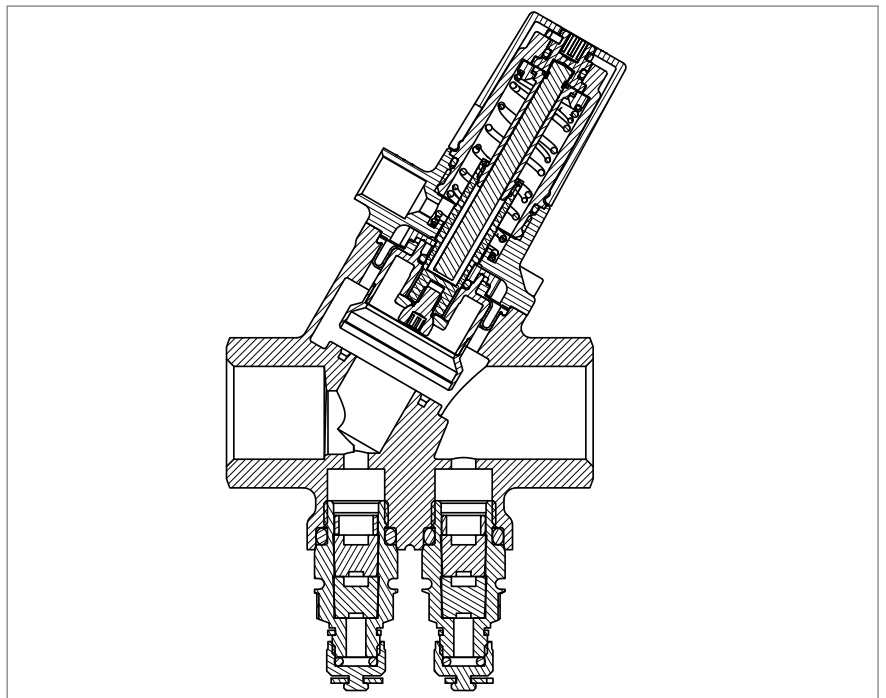

*Frese PV Compact cross section drawing*

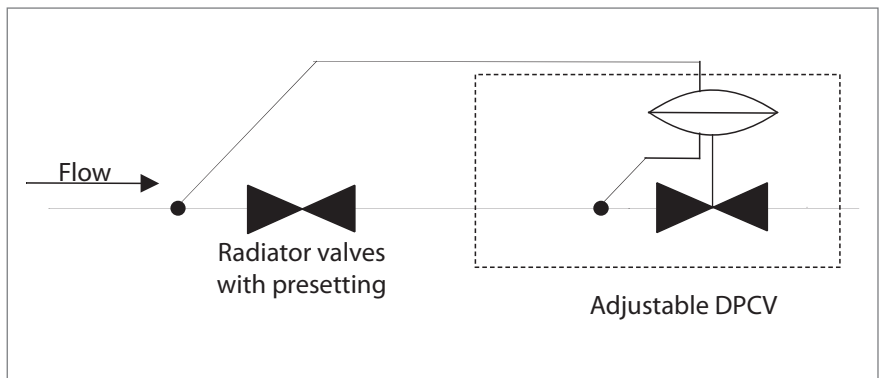

*Frese PV Compact simplified outline*

## Frese PV Compact - adjustable differential pressure control valve

### Technical data

<b>Housing DN15-32:</b>	DZR Brass
<b>DN40-50:</b>	Ductile Iron
<b>DP controller:</b>	PPS 40% glass
<b>Spring:</b>	Stainless steel
<b>Diaphragm:</b>	HNBR
<b>O-rings:</b>	EPDM
<b>Pressure class:</b>	PN25
<b>Max. differential pressure:</b>	450 kPa
<b>Temperature range:</b>	-10°C to + 120°C
<b>Capillary tube:</b>	Ø3, L = 1000mm

The pipe system shall be properly ventilated to avoid risk of air pockets. Glycolic mixtures up to 50% are applicable (both ethylene and propylene).  
Recommendation: Water treatment to VDI 2035.

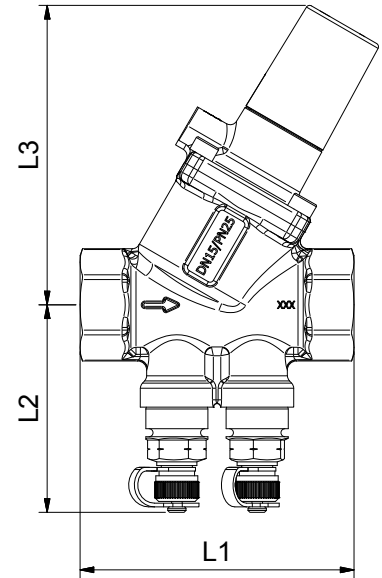
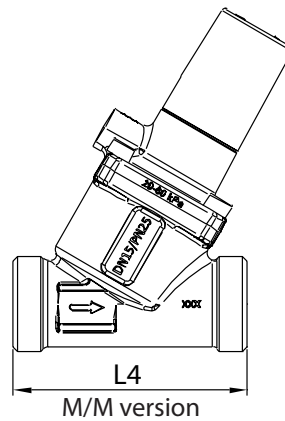



Frese PV Compact										
Dimension		DN15		DN20		DN25		DN32	DN40	DN50
Control range	kPa	5 - 30	20 - 60	5 - 30	20 - 60	5 - 30	20 - 80	20 - 80	20 - 80	20 - 80
	l/s	0.014-0.167	0.028-0.278	0.028-0.278	0.042-0.556	0.167-0.694	0.208-1.167	0.278-1.389	0.833-2.222	1.389-3.194
Flow rate	l/h	50-600	100-1000	100-1000	150-2000	600-2500	750-4200	1000-5000	3000-8000	5000-11500
	gpm	0.22-2.65	0.44-4.41	0.44-4.41	0.66-8.82	2.65-11.02	3.30-18.52	4.41-22.05	13.21-35.22	22.01-50.63
Kvs	m3/h	2.9		4.7		8.7		10.1	15.8	16.2
Dim. mm	L1	75		79		100		104	138	138
	L2	57		57		63		68	71	77
	L2 *	66		66		72		77	80	86
	L3	82		82		134		134	156	156
	L4	65		-		-		-	-	-
Weight	kg	0.71		0.73		1.57		1.72	3.12	3.55

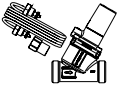

(\*) Valves with drain

## Frese PV Compact - adjustable differential pressure control valve

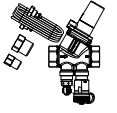
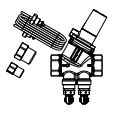
### Product programme

Dimension		DN15		DN20		DN25		DN32	DN40	DN50
		5-30 kPa	20-60 kPa	5-30 kPa	20-60 kPa	5-30 kPa	20-80 kPa	20-80 kPa	20-80 kPa	20-80 kPa
M/M, capillary tube, 1/4" adapter		53-3200	53-3201	-	-	-	-	-	-	-
M/M, capillary tube, 1/2" adapter		53-3202	53-3203	-	-	-	-	-	-	-
F/F, Drain valve, P/T plug, capillary tube, 1/4" & 1/2" adapter		53-3242	53-3243	53-3244	53-3245	53-3246	53-3247	53-3248	53-3249	53-3250
F/F, P/T plugs, capillary tube, 1/4" & 1/2" adapter		53-3204	53-3205	53-3206	53-3207	53-3210	53-3211	53-3214	53-3216	53-3218

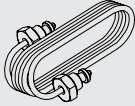
### Accessories

Frese capillary tube ø3mm x 1000 mm		48-0004
Couplings for DN15 M/M incl. gasket. Set with 2 pcs.		43-2330

## Frese PV Compact - adjustable differential pressure control valve

Example: Outline of the heating system. 5 blocks with 4 flats in each.

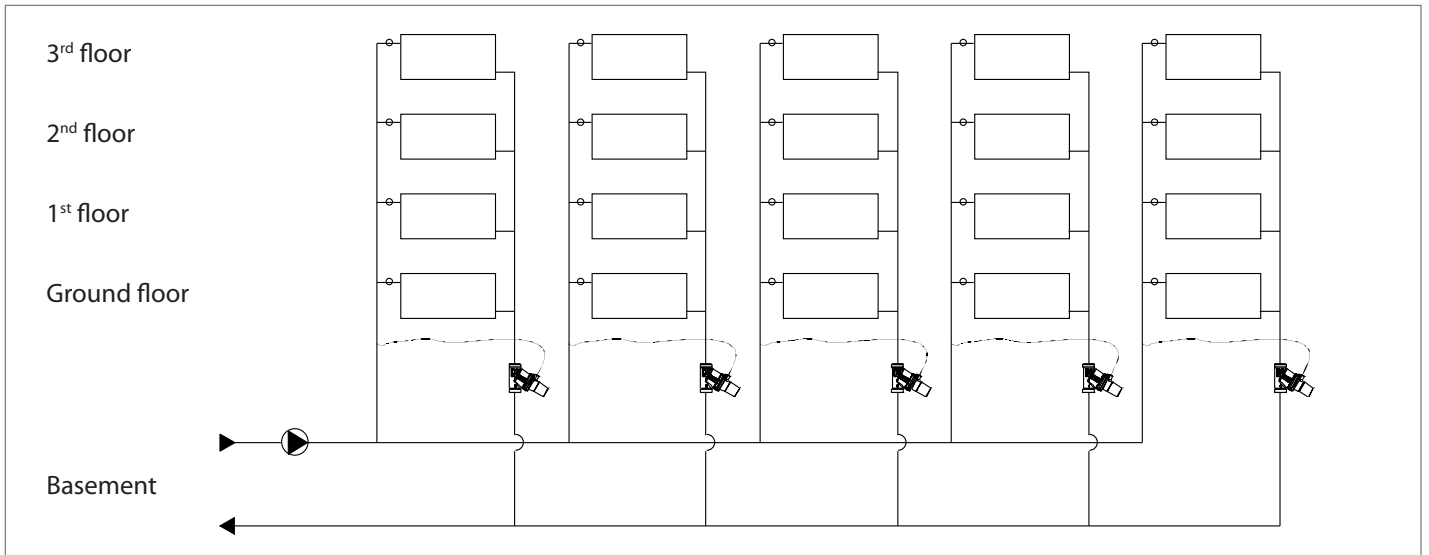

In this case the purpose of Frese PV Compact is to maintain pressure of approx. 12 kPa across the supply and the return line. Specifying the characteristics of the building, the calorific requirement was rated at 125 l/h per flat.

As already mentioned a differential pressure of 12 kPa should be maintained at a flow of  $4 \times 125 = 500$  l/h.

The adjustment setting of the Frese PV Compact valve is specified on the basis of the graph. In order to make reading easier the graphs indicating the pressure in the circuit are arranged at intervals of 5 kPa. Still, the graphs can be offset according to the specified pressure of 12 kPa in our circuit.

In the given example we want to maintain 12 kPa in the circuit at a flow rate of 500 l/h. From the intersection of the 12 kPa graph and the horizontal line indicating 500 l/h a line perpendicular to the x-axis is made to read the pre-set value. Now you will see that the valve is to be pre-set by app. 6 turns on the scale. The minimum differential pressure required will be 3.0 kPa across the valve.

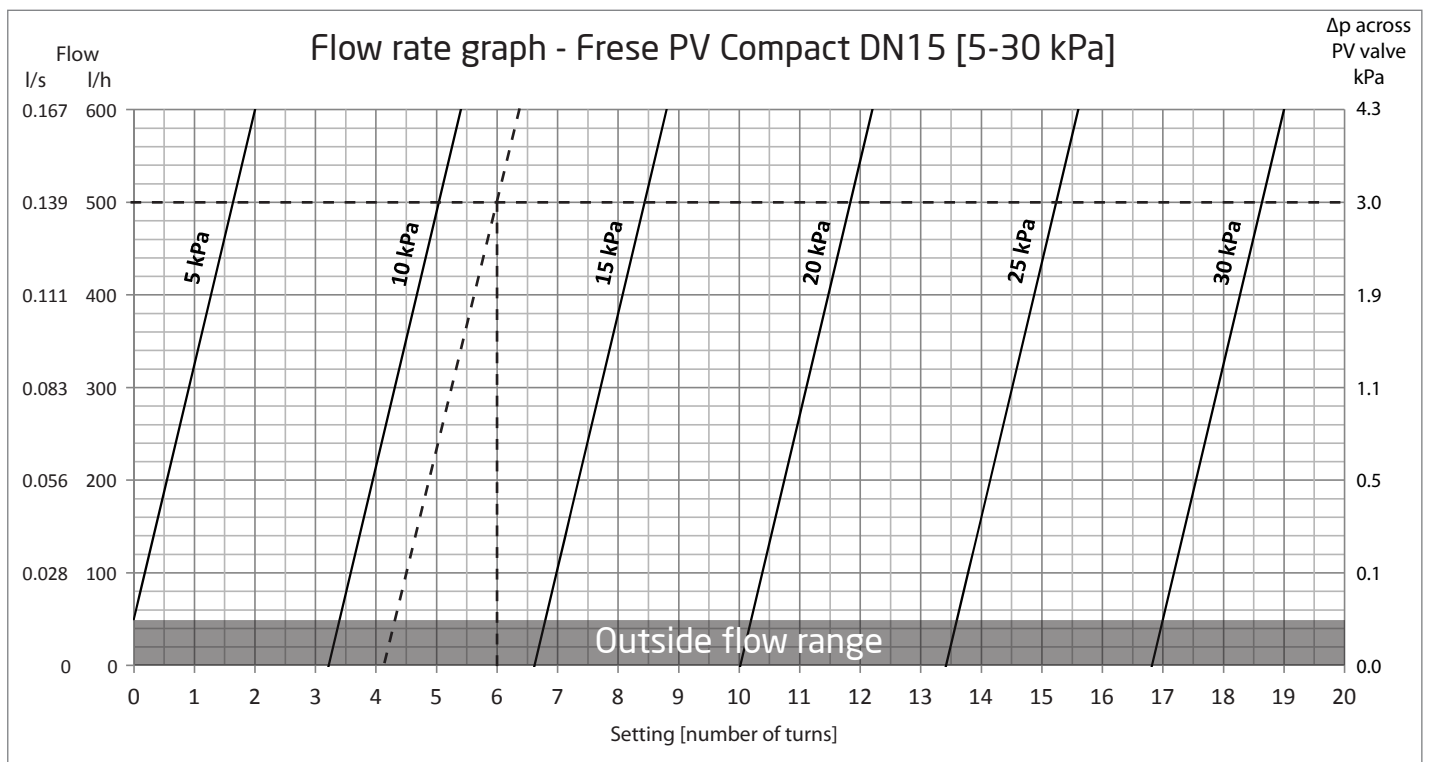

# Frese PV Compact - adjustable differential pressure control valve

## Example

**Please note:**

As the flow is reduced in the circuit in question the pressure increases in reverse ratio to the flow, which is due to the P-band of the adjustment spring.

The valve compensates for this, however the pressure will at no point in the circuit be as high as the pump pressure that would have been available, if Frese PV Compact had not been installed.

In this example the pressure increases to approx. 14 kPa as the graph is offset parallel to the course of flow. Furthermore, you can always read from the graph what the pressure in the circuit will be at any flow rate below the rated 500 l/h.

The grey area in the bottom of the graph indicates flow outside the range.

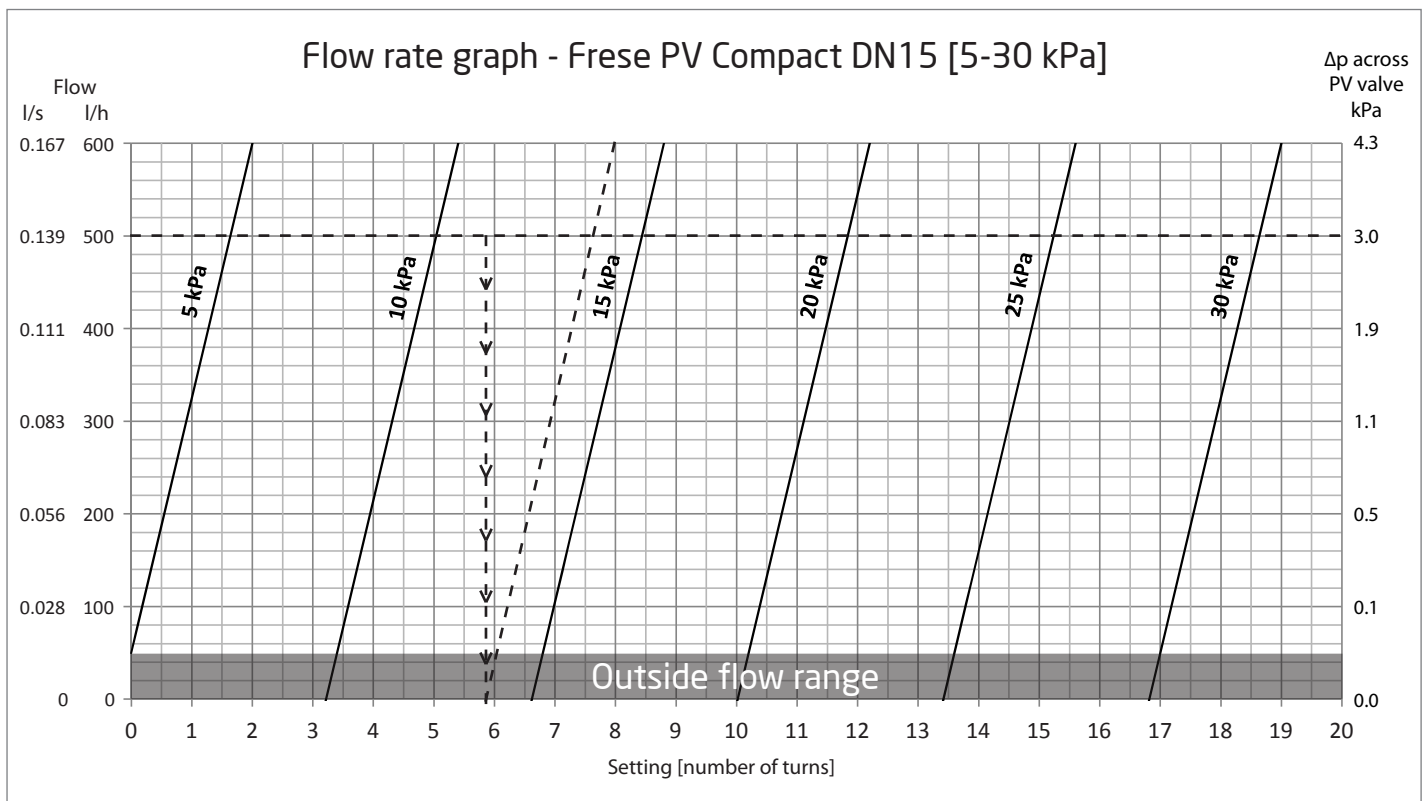

## Frese PV Compact - adjustable differential pressure control valve

### Frese PV Compact DN15, 5-30 kPa

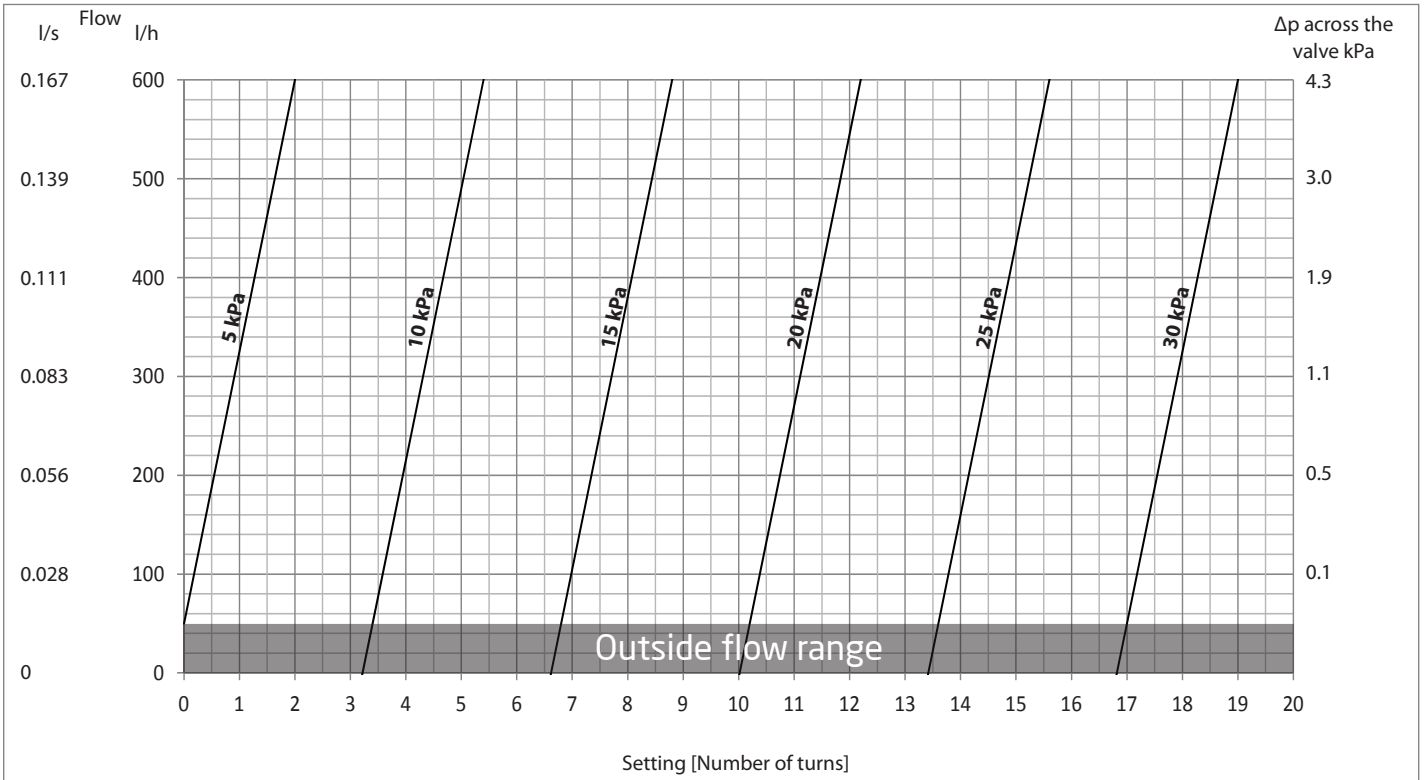

### Frese PV Compact DN15, 20-60 kPa

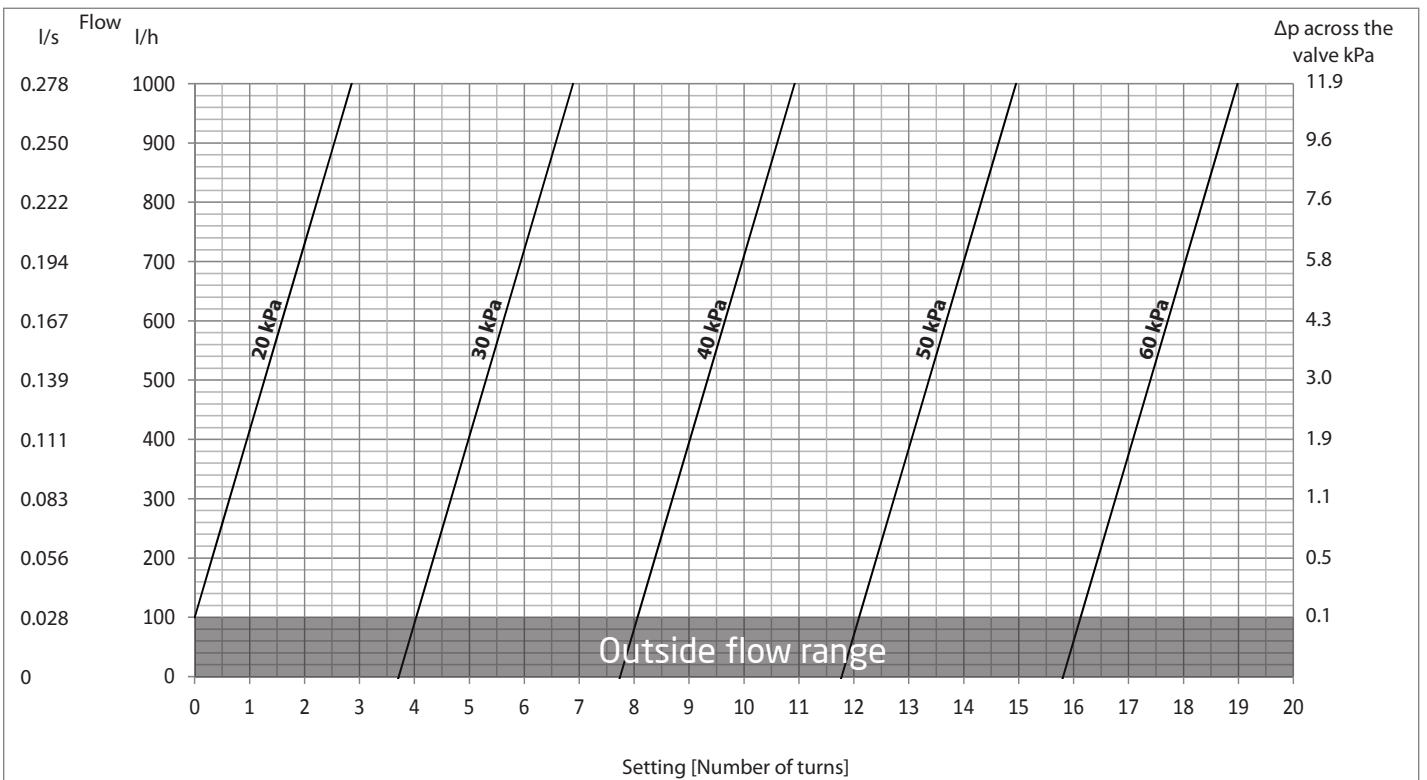

## Frese PV Compact - adjustable differential pressure control valve

### Frese PV Compact DN20, 5-30 kPa

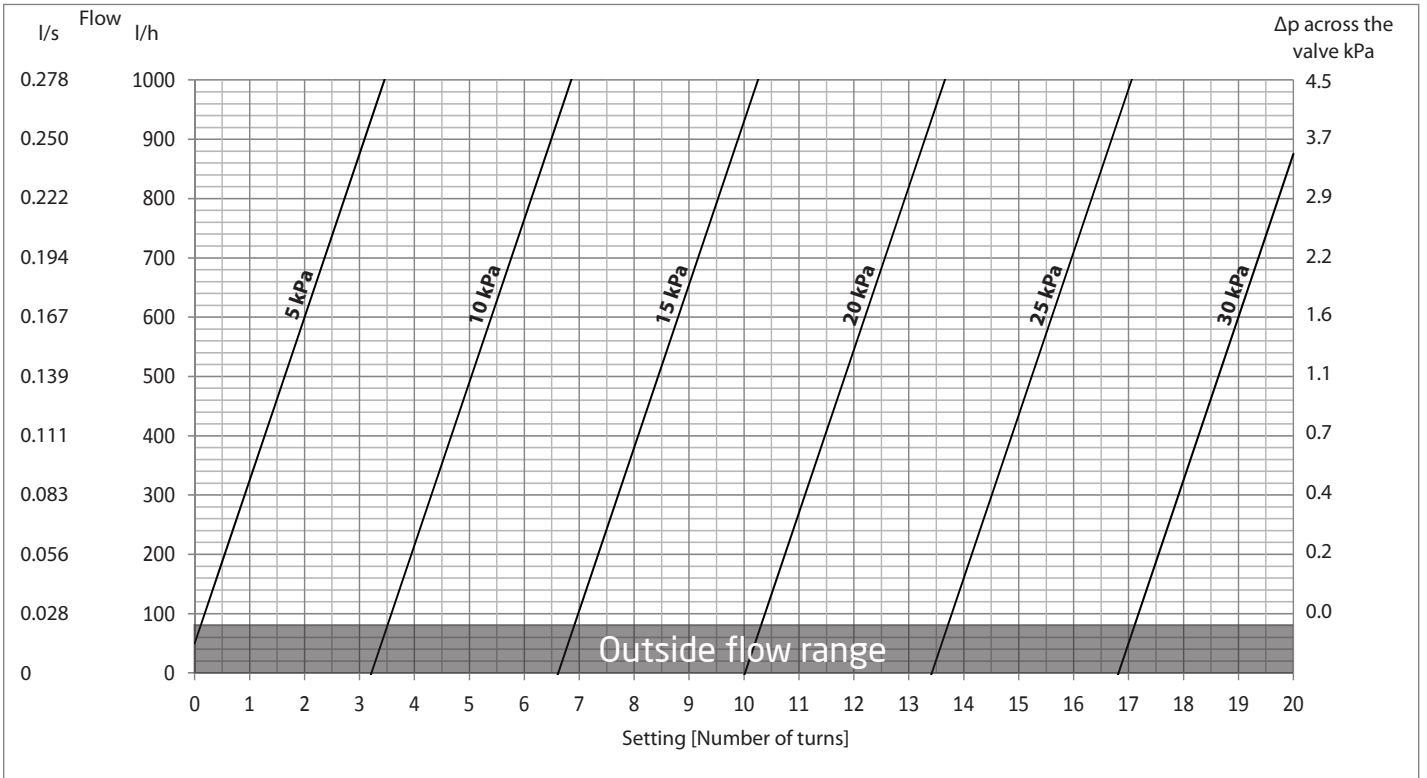

### Frese PV Compact DN20, 20-60 kPa

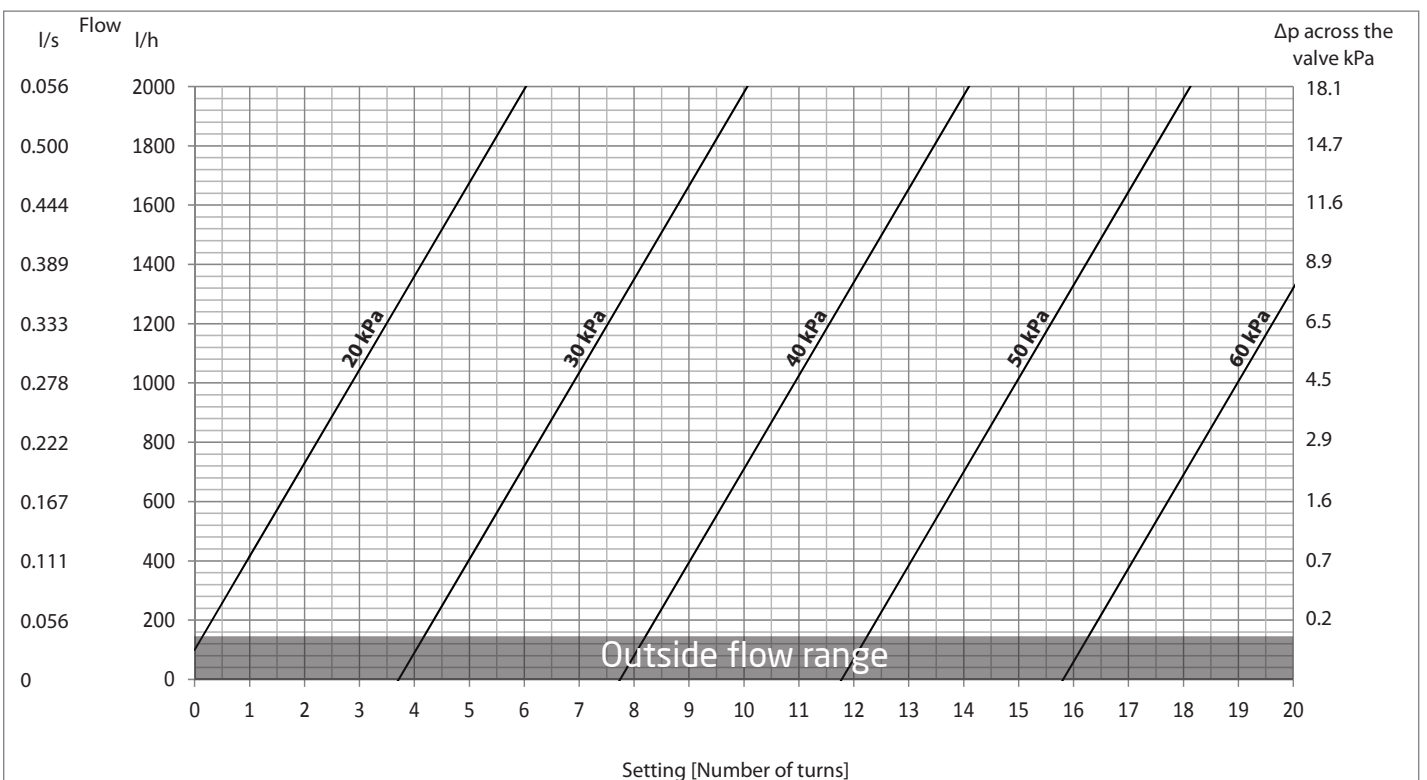



## Frese PV Compact - adjustable differential pressure control valve

### Frese PV Compact DN25, 5-30 kPa

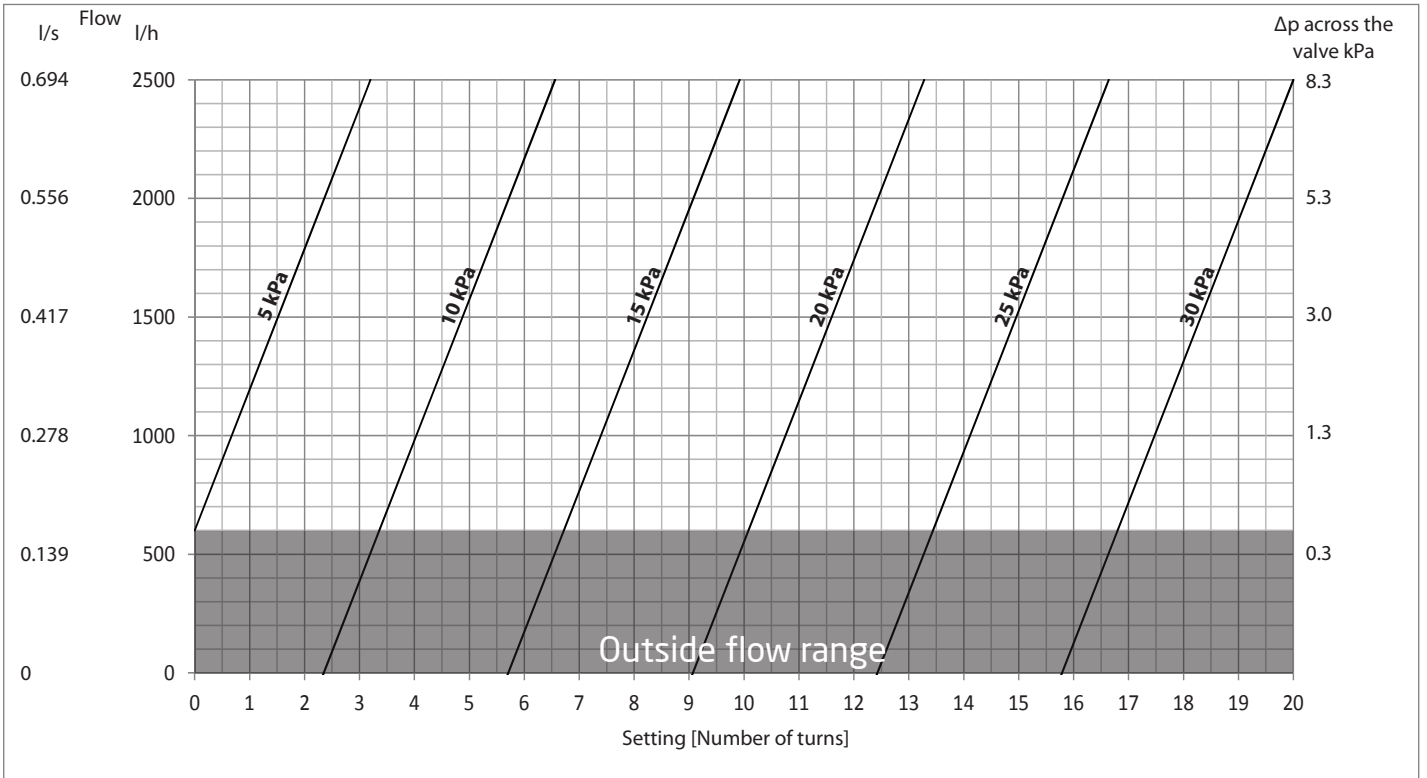

### Frese PV Compact DN25, 20-80 kPa

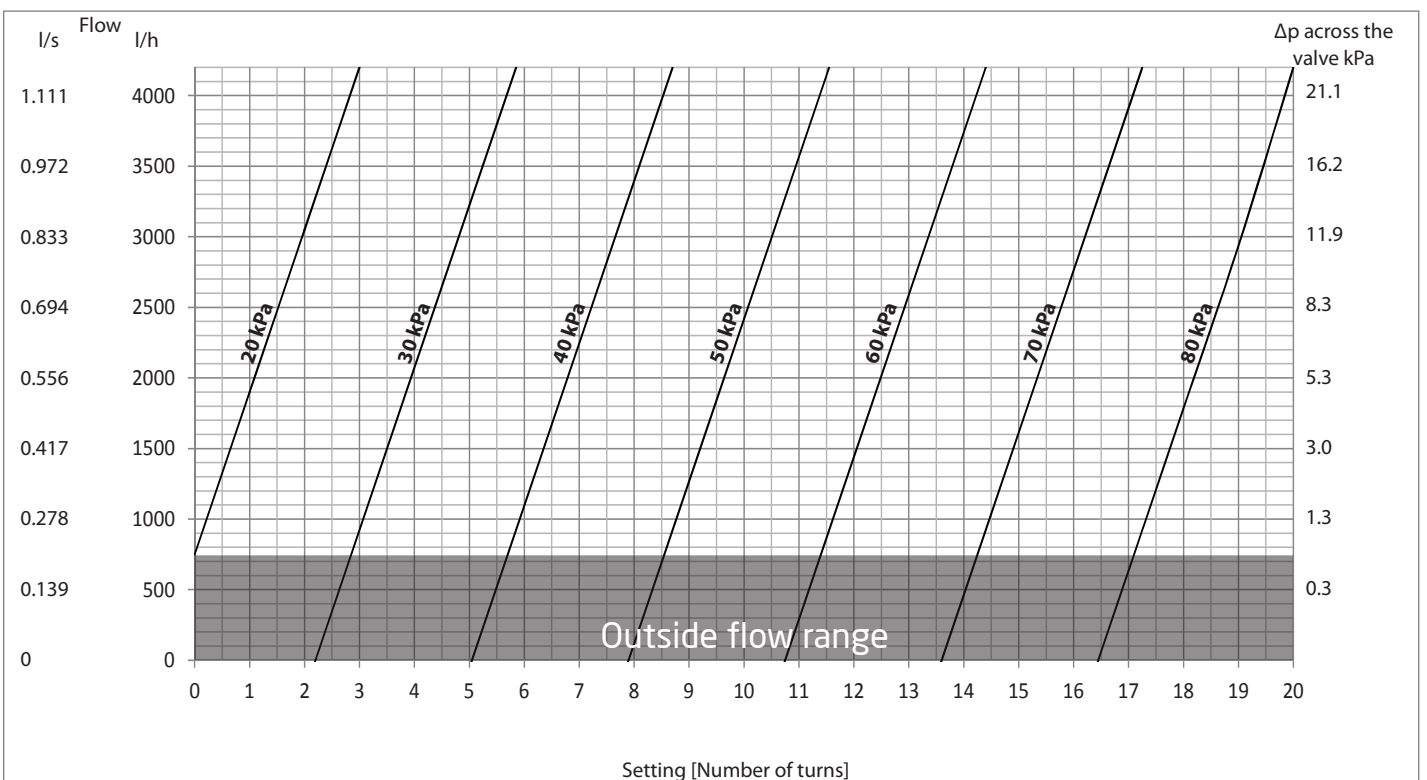

## Frese PV Compact - adjustable differential pressure control valve

### Frese PV Compact DN32, 20-80 kPa

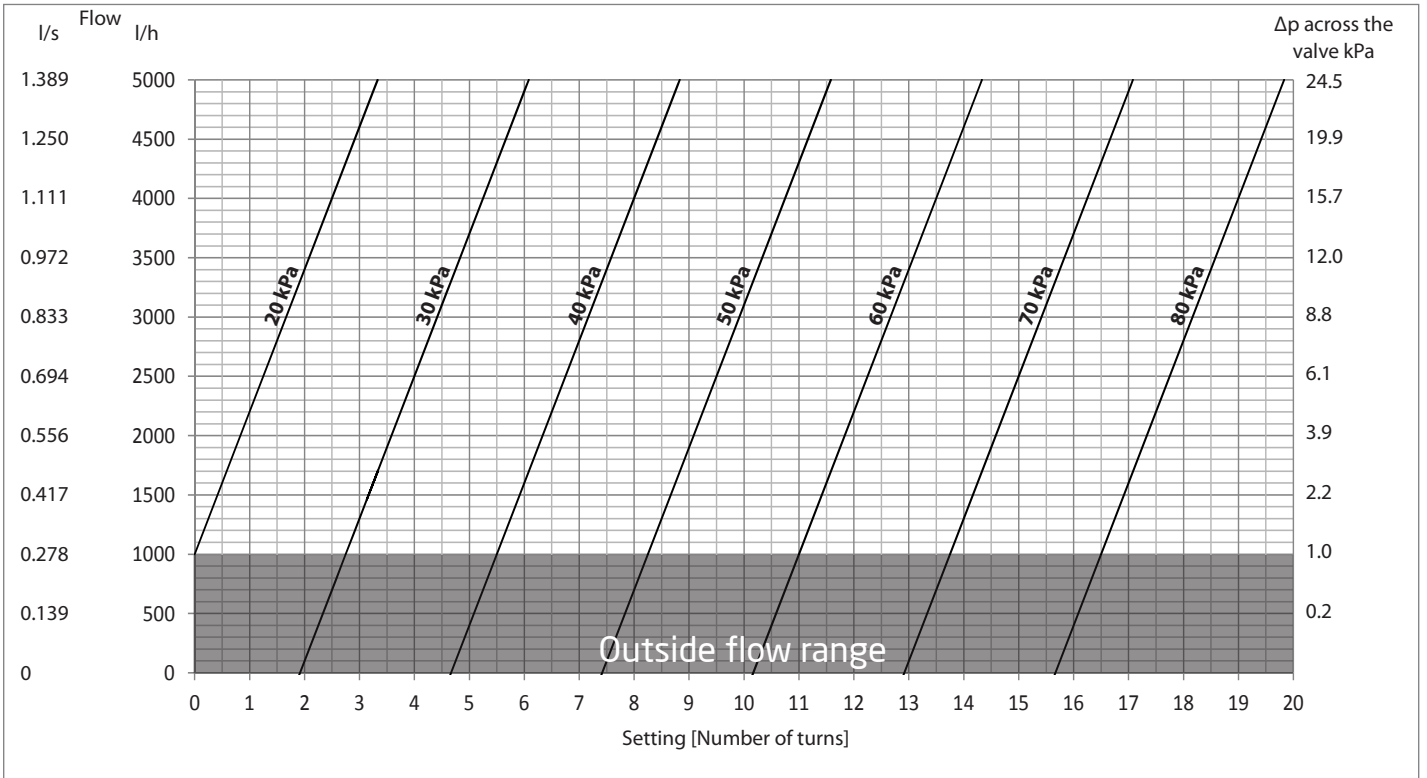

### Frese PV Compact DN40, 20-80 kPa

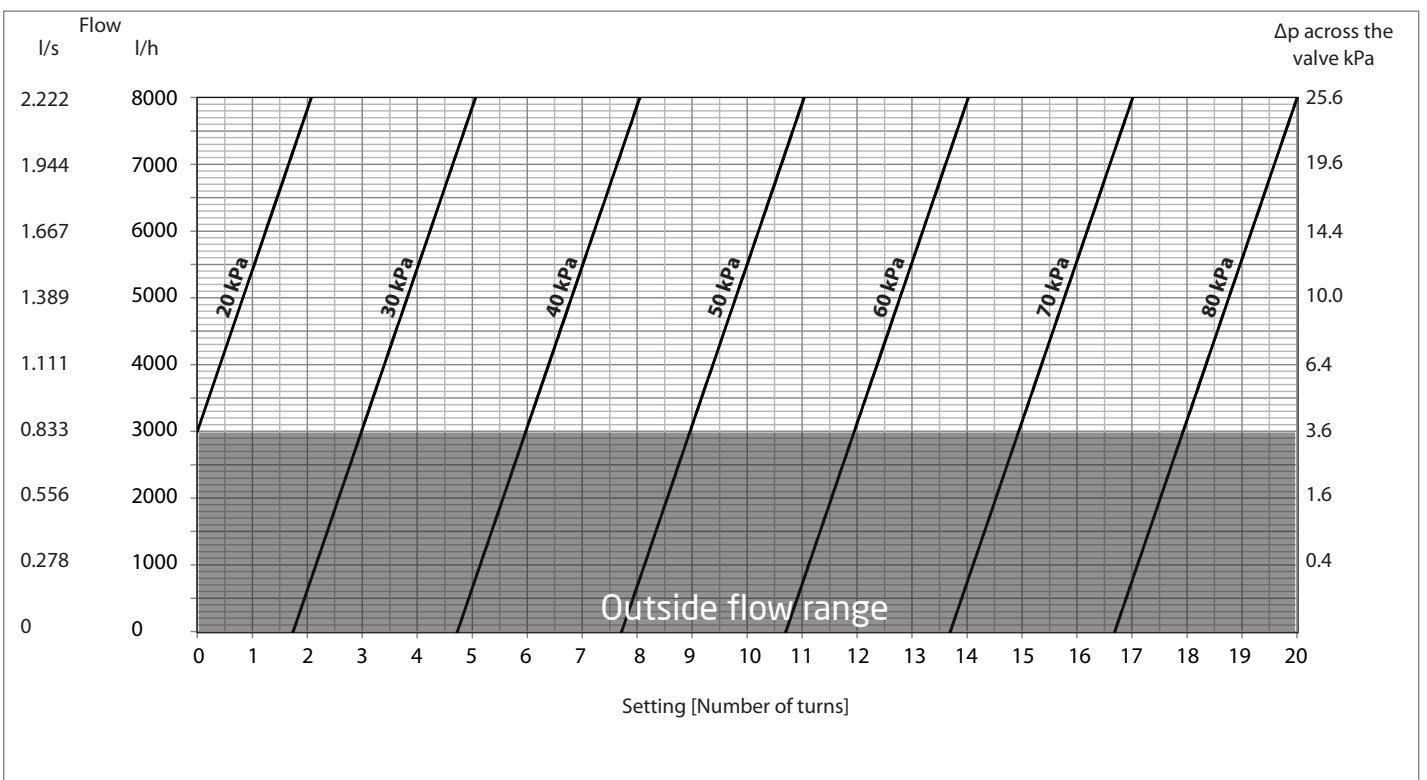

## Frese PV Compact - adjustable differential pressure control valve

### Frese PV Compact DN50, 20-80 kPa

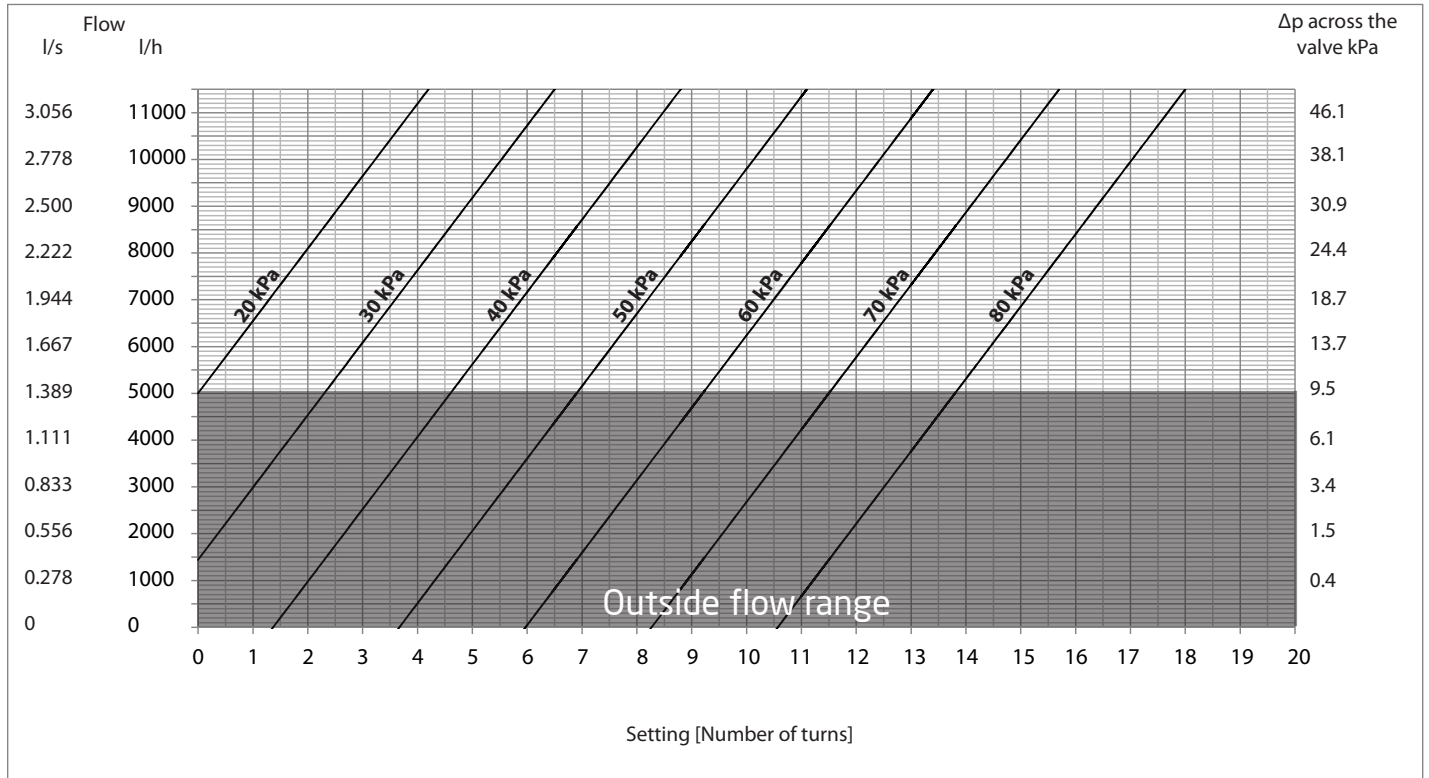

### Text for technical specifications

The valve should be a dynamic differential pressure control valve with the option of setting the differential pressure on site without suspension of operation.

The valve should limit the differential pressure in a circuit.

The valve scale should only be adjustable by means of a key.

The valve should be permanently marked with an indicator for flow direction.

The valve should be pressure rated PN25.

The valve shall operate with a differential pressure up to 450 kPa.

The valve shall have a control range of 5-30 kPa, 20-60 kPa or 20-80 kPa.

Frese A/S assumes no responsibility for errors, if any, in catalogues, brochures, and other printed matter. Frese A/S reserves the right to modify its products without prior notice, including already ordered products, if this does not alter existing specifications. All registered trademarks in this material are the property of Frese A/S. All rights reserved.

Frese A/S  
Sorøvej 8  
DK- 4200 Slagelse  
Tel: +45 58 56 00 00  
Fax: +45 58 56 00 91  
info@frese.dk